

Cooling Only
Cooling Heating
50 Hz Models
 MCD 512 DB
 MCD 518 DB
 MCD 524 DB
 MCD 530 DB
 MCD 536 DB
 MCD 048 DB
 MCD 060 DB

Cooling Only
Cooling Heating
60 Hz Models
 MCD 512 D1
 MCD 518 D1
 MCD 524 D1
 MCD 530 D1
 MCD 536 D1
 MCD 048 D1
 MCD 060 D1

Cooling
Cooling Heating
50Hz Models
 MCDA 18 DB
 MCDA 24 DB
 MCDA 30 DB
 MCDA 36 DB
 MCDB 42 DB
 MCDB 48 DB
 MCDB 60 DB

Cooling
Cooling Heating
60 Hz Models
 MCDA 18 D1
 MCDA 24 D1
 MCDA 30 D1
 MCDA 36 D1
 MCDB 42 D1
 MCDB 48 D1
 MCDB 60 D1

Model Series 5
Cooling Only
(50 Hz)
 MCD 009 AA5
 MCD 012 AA5
 MCD 018 AA5
 MCD 024 AA5
 MCD 030 EB5
 MCD 036 EB5
 MCD 042 EB5

Installation Manual

ILLUSION

Split System Concealed Type

MCD Series 50/60 Hz

General Information

Introduction

This Installation Manual is given as a guide to good practice in the installation by the installer of MCD mini-split system. Installation procedures should be performed in the sequence that they appear in this manual. For installing the unit to operate properly and reliably, it must be installed in accordance with these instructions. Also, the services of a qualified service technician should be employed, through the maintenance contract with a reputable service company.

Read these installation instructions completely before installing the air conditioning system.

About the Unit

These MCD units are assembled, pressure tested, dehydrated, charged and run tested before shipment. The information contained in this manual applies to MCD units are designed to operate in cooling mode only and in cooling or heating modes.

Important

This document is customer property and is to remain with unit. Please place in service information pack upon completion of work. These instructions do not cover all variations in systems, nor do they provide for every possible contingency to be met in connection with installation.

Should further information be desired or should particular problems arise which are not covered sufficiently in this manual, the matter should be referred to your authorized Trane dealer.

Caution

Cautions are provided at appropriate places in this manual to indicate to installers, operators, and service personnel of potentially hazardous situations which, if not avoided, MAY result in minor or moderate injury or malfunction of the unit.

Location and Preparation of Units

Indoor Unit

1. Select a convenient location that allows the air to reach every corner of the room and where it is easy to route the refrigerant tubing, wiring and drain to the outside.
2. The ceiling construction should be strong enough to support the weight of the unit.
3. The refrigerant tubing, drain piping and wiring conduit are connected through the wall.
4. Refrigerant tubes between the indoor and the outdoor units and drain pipes should be as short as possible.
5. If a refrigerant charge adjustment is necessary, follow the Installation Manual for the Outdoor Unit.

Outdoor Unit

See instructions for location and preparation of the unit in the Installation Manual for the Outdoor Unit.

Installation Method:

Indoor Unit

After selecting the location to place the unit, follow these steps:

1. Make a hole in the wall to route tubing and wiring through a locally purchased PVC pipe. The hole should slope downwards slightly, towards the outside (Figure 1).
2. Before cutting, check that no pipes or studs are directly behind the place to be cut. Avoid areas where electrical wiring or conduits are located.
3. Hang the unit on a solid and level roof. Noise, vibration or leakage could occur on an unstable foundation (Figure 3, 4). For correct installation of duct work see (Figure 6).
4. Support the unit solidly.
5. To have access to electrical terminals, remove the right side junction box (Figure 2).
6. Note that refrigerant tubing, interconnecting wiring and drain hose should go through the wall. Shape these items so that they will easily fit through the wall.

Outdoor Unit

See the proper installation method provided in the Installation Manual for the Outdoor Unit.

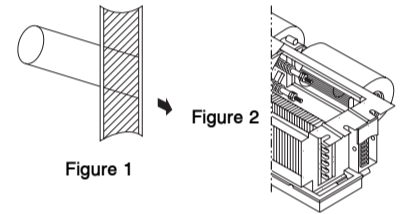
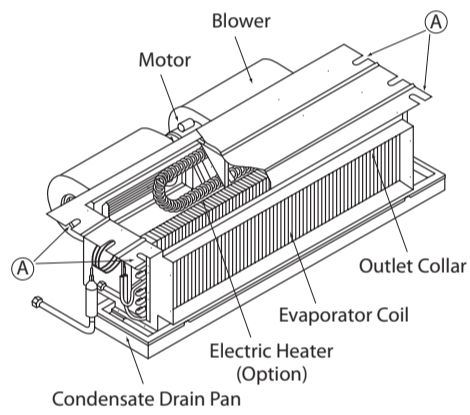

Figure 1

Figure 2

System Appearance

MCD 512-536 DB/D1
 MCD 009-024 AA5



Note (A) Hanger recommendation for without return plenum model

MCD 048-060 DB/D1
 MCD 030-042 EB5
 MCDA 18-A36 DB/D1
 MCDB42-B60 DB/D1

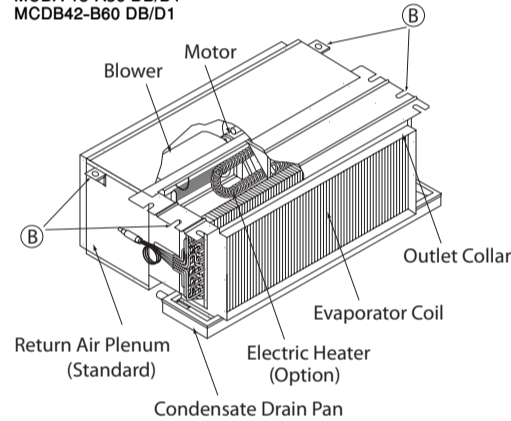

Note (B) Hanger recommendation for return plenum model

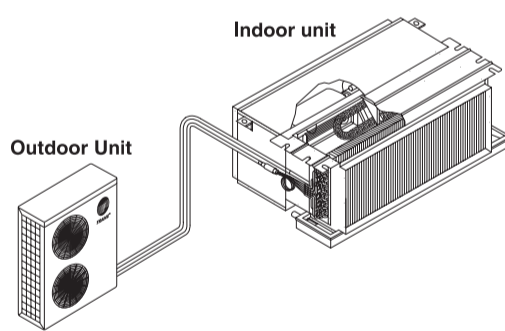
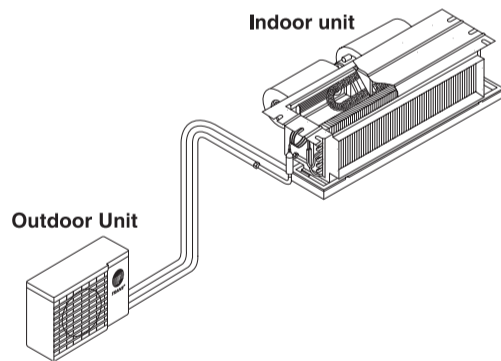

Connection of Refrigerant Tubing

Proper installation procedure is recommended in the Installation Manual Package, usually provided together with the outdoor unit. It is advisable to read before installing.

The indoor unit refrigerant connections are located on the left hand side when facing the unit (Figure 7).

Connecting the Units with Flaring Procedure

1. Cut the copper tube to the required length with a tube cutter. It is recommended to cut approx. 20-30 cm. longer than the tubing length.
2. Remove burrs at the end of the copper tube with a tube reamer or file, as shown in Figure 8.

When reaming, hold the tube end downward and be sure that no copper scraps fall into the tube (Figure 9).

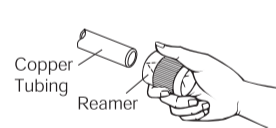

Figure 8

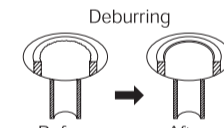

Figure 9

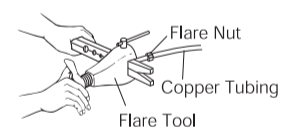

Figure 10

3. Remove the flare nut from the unit and be sure to insert on the copper tube.
4. Make a flare at the end of the copper tube with a flare tool (Figure 10).

Flare Specification

Copper diameter, In.(mm.)	H, (mm.)	D, (mm.)
1/4" (6.35)	1.0 - 2.0	8.6 - 9.7
3/8" (9.53)	1.0 - 3.0	12.4 - 13.9
1/2" (12.70)	1.0 - 2.0	15.7 - 16.1
5/8" (15.88)	1.0 - 3.0	19.0 - 20.3
3/4" (19.05)	1.0 - 3.0	22.4 - 22.7

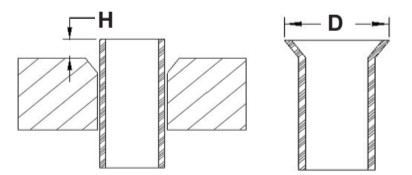

Figure 17

A good flare should have the following characteristics:

- Inside surface is glossy and smooth.
- Edge is smooth.
- Tapered sides are of uniform length.

Cautions Before Connecting Tightly

1. Be sure to apply a sealing cap or water-proof tape to prevent dust or water from getting into the tubes before they are used.
2. Be sure to apply refrigerant lubricant to the matching surfaces of the flare and union before connecting them together. This is effective for reducing gas leaks (Figure 11).
3. For proper connection, align the union tube and flare tube straight with each other, then screw in the flare nut lightly at first to obtain a smooth match (Figure 12).
4. Tighten the flare nuts, using the appropriate wrench.

Connecting the Unit with Brazing Procedure

1. Cut the copper tube to the required length with a tube cutter. It is recommended to cut approx. 20-30 cm. longer than the tube length.
2. Remove burrs at the end of the copper tube with a tube reamer (Figure 8).
3. There are 2 ways to connect the copper tube
 - Use a coupling between the copper tube of Fan Coil Unit and the copper tube used for installation (Figure 13).
 - Expand the copper tube by using a swaging tool set as in Figure 14.
4. To braze the copper tube, before brazing a copper tube to a solder coupling or a copper tube to an expanded tube, do not forget to keep them tight as shown in Figure 15.
5. While welding copper tube. You should to Nitrogen flow in tube for protect soot occurred.

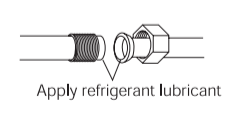

Figure 11

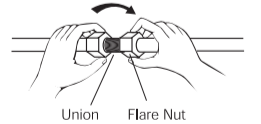

Figure 12

Units Installation

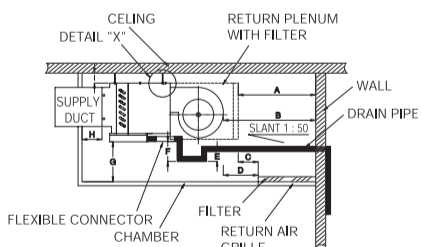

Figure 3 (SIDE VIEW)

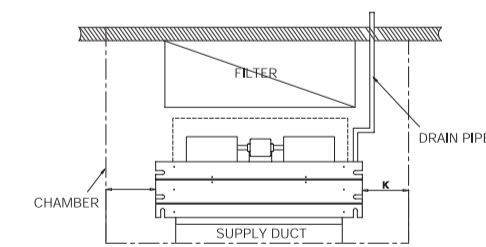

Figure 4 (TOP VIEW)

Table 1	A	B	C	D	E	F	G	H	I	J	K
DISTANCE (MM.)	Min. 750	Min. 800	100	150	50	200	Min. 200	Min. 100	Min. 50	Min. 300	Min. 300

NOTE: FOR DUCT LENGTH PLEASE SEE TABLE 2, 3, 4

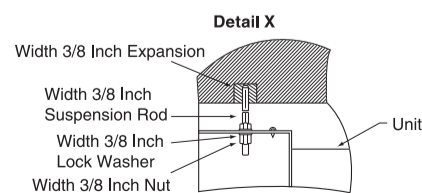

Figure 5

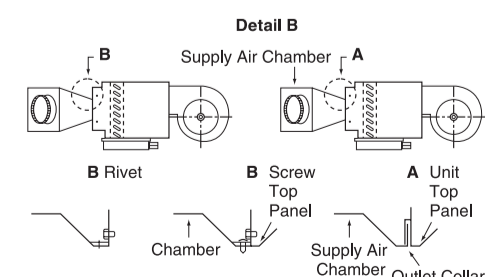

Figure 6

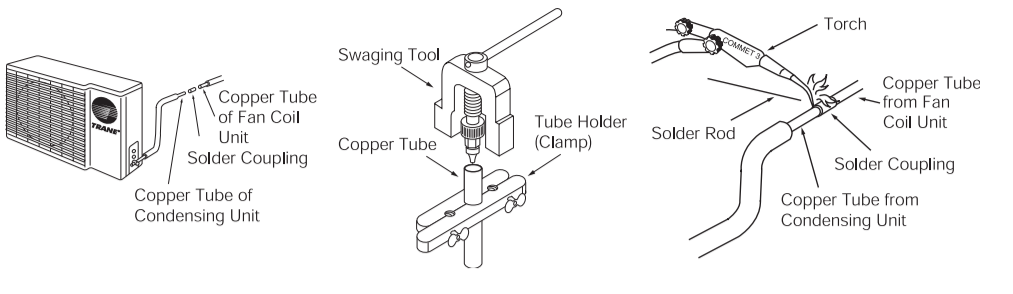

Figure 13

Figure 14

Figure 15

Condensate Drain Piping

1. The drain hose should run straight down the wall to a level where the run off will not stain the wall.
2. These should be no water traps. Avoid putting the end of the hose in water.
3. To conveniently drain the system, the drain piping must slant downward, with a slope of at least 1:50 to prevent leakage.
4. When the drain hose is placed in the room, insulate the hose with foam polyethylene to avoid damage to the ceiling or furniture.
5. After completing installation of refrigerant lines, wiring and drain connections, bind the tubing, wiring and drain piping (check if local codes permit binding) into a bundle by using tape at 100 or 200 mm (4" to 8") intervals. Make sure the drain tube is at the bottom of the bundle (Figure 16).

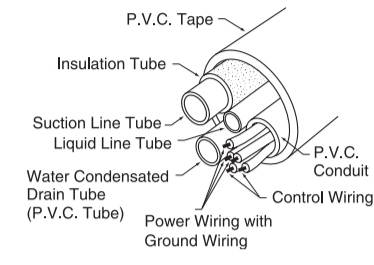
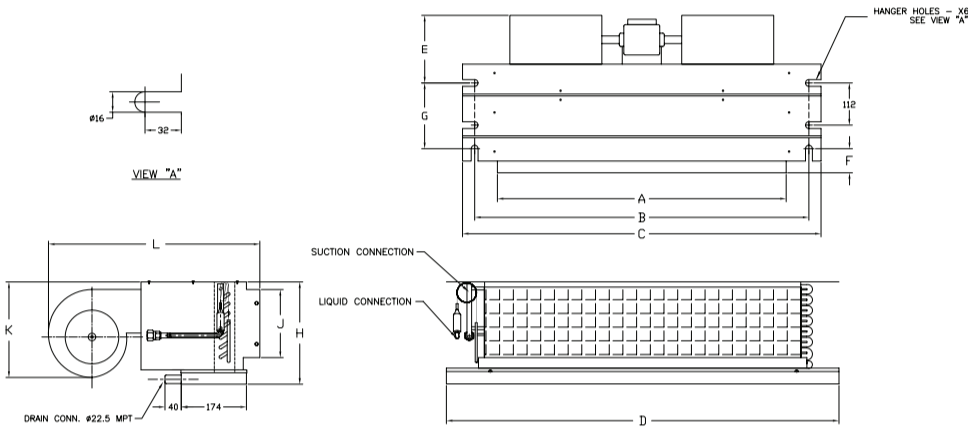

Figure 16

Dimensional Data



Model	All External Dimensions are in mm.											Refrig Line Conn. Size.		Number Of Fan(s)	Motor(s)
	A	B	C	D	E	F	G	H	J	K	L	Liquid	Suction		
MCD09AA5	794	845	883	946	250	35	152	260	193	228	445	1/4"(6.35)	1/2"(12.7)	2	1
MCD012AA5	794	845	883	946	250	35	152	260	193	228	445	3/8"(9.53)	5/8"(15.87)	2	1
MCD016AA5	972	1022	1061	1098	310	35	152	260	193	228	482	3/8"(9.53)	5/8"(15.87)	2	1
MCD024AA5	972	1022	1061	1098	360	35	152	260	193	325	520	3/8"(9.53)	5/8"(15.87)	2	1
MCD5120B/D1	764	882	946	946	274	64	181	258	165	252	496	1/4"(6.35)	1/2"(12.7)	2	1
MCD5180B/D1	764	882	946	946	274	64	181	258	165	252	496	1/4"(6.35)	1/2"(12.7)	2	1
MCD5240B/D1	764	882	946	946	274	64	181	258	165	252	510	3/8"(9.52)	5/8"(15.87)	2	1
MCD5300B/D1	916	1034	1098	1098	274	64	181	258	165	252	510	3/8"(9.52)	5/8"(15.87)	2	1
MCD5360B/D1	1069	1187	1251	1251	274	64	181	258	165	252	510	3/8"(9.52)	3/4"(19.05)	2	1

Note : From the experience of our Trane technician, based on the design condition, at velocity at supply air grille of 300 ft./min. for bedroom and 400 ft./min. for office (based on free face area). The length of the air duct should be less than 60 cm. for Model MCD09AA5-024AA5 and the length of duct should be more than 3 m. for Model MCD512D-536D.

Dimensional Data

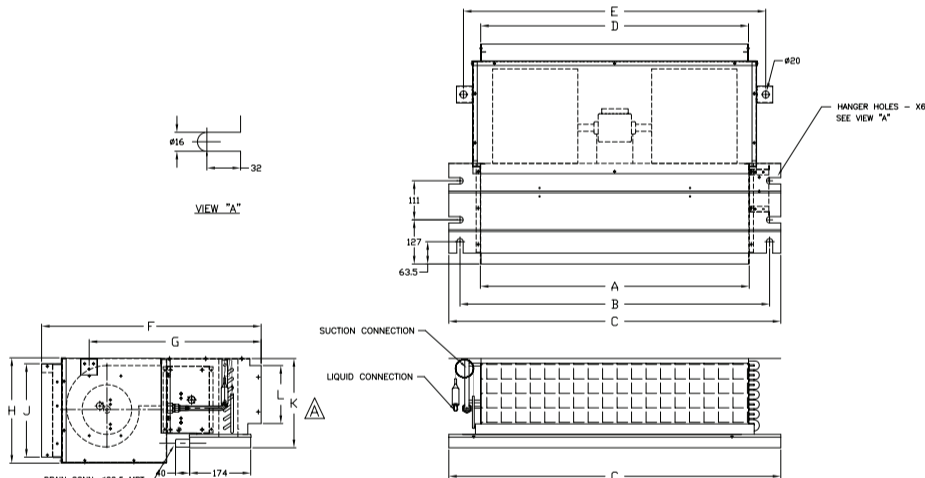

Model	All External Dimensions are in mm.											Refrig Line Conn. Size.		Number Of Fan(s)	Motor(s)
	A	B	C	D	E	F	G	H	J	K	L	Liquid	Suction		
MCD5120B/D1	764	882	946	779	857	625	490	300	266	258	165	1/4"(6.35)	1/2"(12.7)	2	1
MCD5180B/D1	764	882	946	779	857	625	490	300	266	258	165	1/4"(6.35)	1/2"(12.7)	2	1
MCD5240B/D1	764	882	946	779	857	625	490	300	266	258	165	3/8"(9.52)	5/8"(15.87)	2	1
MCD5300B/D1	916	1034	1098	931	1009	625	490	300	266	258	165	3/8"(9.52)	5/8"(15.87)	2	1
MCD5360B/D1	1069	1187	1251	1084	1162	625	490	300	266	258	165	3/8"(9.52)	3/4"(19.05)	2	1
MCD0460B	916	1034	1098	907	1013	759	615	394	354	408	352	1/2"(12.7)	7/8"(22.23)	2	1
MCD0600B	1069	1187	1251	1060	1166	759	615	394	354	408	352	1/2"(12.7)	7/8"(22.23)	2	1
MCD030E5	1069	1187	1251	1084	1162	672	534	348	272	258	165	3/8"(9.53)	3/4"(19.05)	2	1
MCD036E5	916	1034	1098	907	1013	759	615	394	354	408	352	3/4"(19.05)	3/8"(9.53)	2	1
MCD042E5	916	1034	1098	907	1013	759	615	394	354	408	352	7/8"(22.23)	3/8"(9.53)	2	1

Note : From the experience of our Trane technician, based on the design condition, at velocity at supply air grille of 300 ft./min. for bedroom and 400 ft./min. for office (based on free face area). The length of the air duct should be less than 60 cm. for Model MCD030E5-042E5 and the length of duct should be more than 3 m. for Model MCD512D-060D.

Electrical Installation

Electrical Installation

All wiring and grounding must comply with local electrical codes.

Wiring Important Safeguards:

- Check the unit nameplate for electrical rating. Be sure wiring is done according to local codes and wiring diagram.
- Use a separate power line with circuit breaker for each air conditioning unit.
- Connect electrical ground to all units.
- Wiring should not touch refrigerant tubing, compressor, motors or moving parts.
- The manufacturer will accept no responsibility for problems caused by unauthorized changes in the internal wiring.
- Connect the wiring firmly.

Indoor Unit

Remove the right side junction box (see previous instructions) to access the terminal base.

System Wiring Routing

- Pass the system wiring through the PVC pipe, referred to in the Section of Installation Method (both power and control lines) to interconnect indoor and outdoor units.
- Connect the wire terminals to the terminal base. See connection indication on system wiring diagram.
- Make sure all connections are tight.

Outdoor Unit

See the electrical installation instructions in the Installation Manual for the Outdoor Unit.

Caution

In order to avoid a hazard due to inadvertent resetting of the thermal cut-out, this appliance must not be supplied through an external switching device, such as a timer, or connected to a circuit that is regularly switched on and off by the utility.

Wiring Diagram

CONCEALED FAN COIL UNITS COOLING ONLY

- MCD 009-012 AA5 (3 SPEEDS)
- MCD 018-024 AA5 (4 SPEEDS)
- MCD 030 EB5 (4 SPEEDS)
- MCD 036 EB5 (3 SPEEDS)
- MCD 512-536 DB/D1 (4 SPEEDS)
- MCD 048-060 DB/D1 (4 SPEEDS)
- MCD 042 EB5 (4 SPEEDS)
- MCD A 18-A36 DB/D1 (4 SPEEDS)
- MCD B 42-B60 DB/D1 (4 SPEEDS)

Remove HI-BR wire from TB-1 and replace with EXTRA HI-BLK wire when high speed/cfm is required in the field.

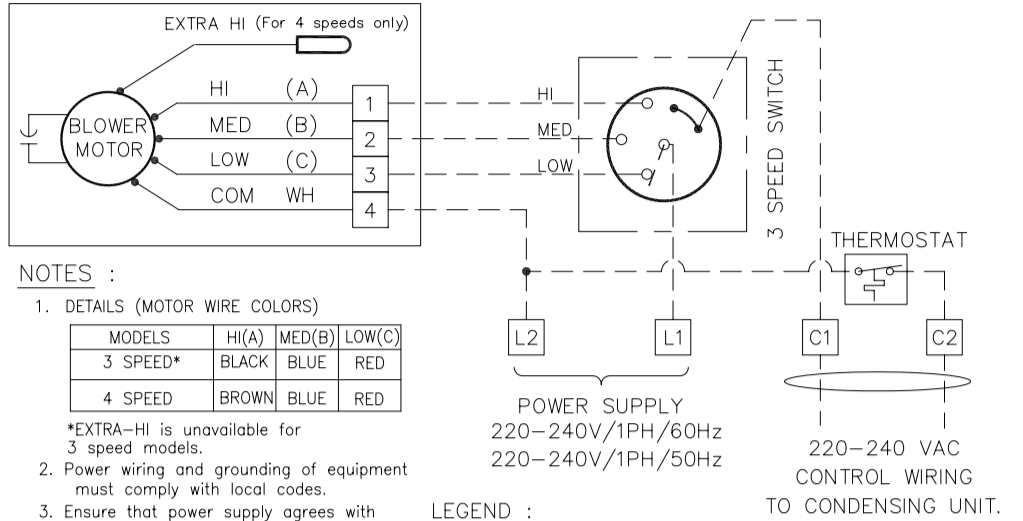

- NOTES :
1. DETAILS (MOTOR WIRE COLORS)
 2. Power wiring and grounding of equipment must comply with local codes.
 3. Ensure that power supply agrees with equipment nameplate.
 4. Use only copper conductors.

MODELS	HI(A)	MED(B)	LOW(C)
3 SPEED*	BLACK	BLUE	RED
4 SPEED	BROWN	BLUE	RED

*EXTRA-HI is unavailable for 3 speed models.

LEGEND :
 - - - - - FIELD WIRING
 _____ FACTORY WIRING

Wiring Diagram

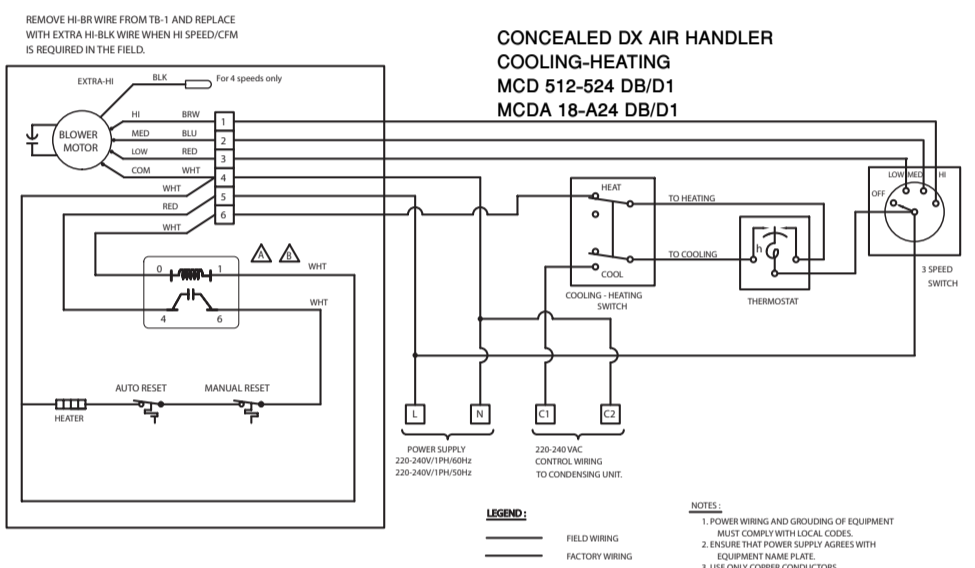

- REMOVE HI-BR WIRE FROM TB-1 AND REPLACE WITH EXTRA HI-BLK WIRE WHEN HI SPEED/CFM IS REQUIRED IN THE FIELD.

Wiring Diagram

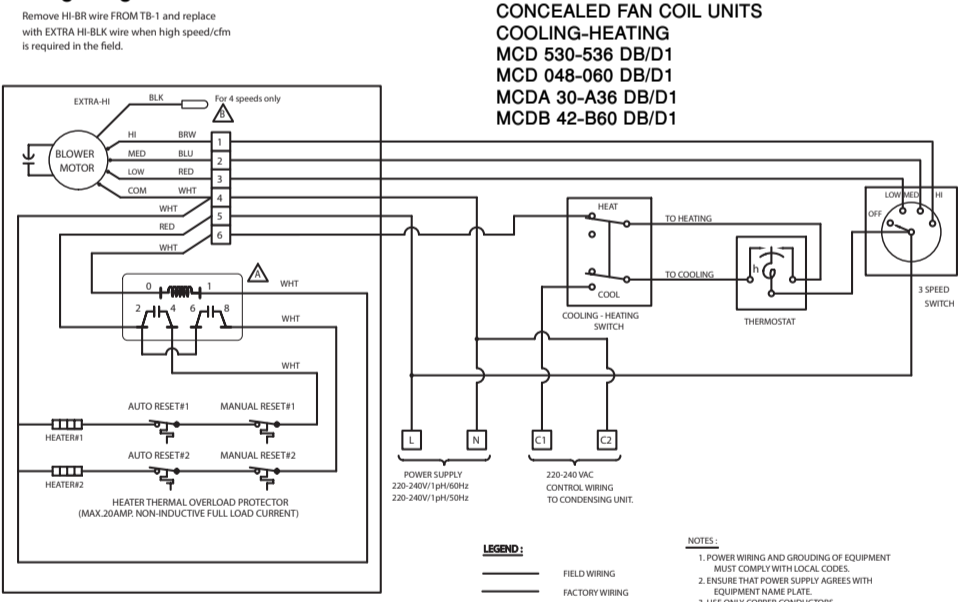

- REMOVE HI-BR WIRE FROM TB-1 AND REPLACE WITH EXTRA HI-BLK WIRE WHEN HI SPEED/CFM IS REQUIRED IN THE FIELD.

LEGEND :
 - - - - - FIELD WIRING
 _____ FACTORY WIRING

Maintenance

Regular Maintenance

Be sure to disconnect the power before inspection or maintenance air conditioner.

1. Cleaning the air filter

Air flow is reduced and cooling efficiency impaired if the filter is clogged. Be sure to clean the filter every two weeks during the cooling season.

1.1 Remove air filters to side

- Slide air filter to left or right side.

1.2 Remove air filters to bottom

- Loose screws located under the filters at return air plenum set.
- Remove air filter frame and pull air filter down.

How to clean the air filter

- Wash away dust from the air filters with clean water or vacuum it with an electric vacuum cleaner

Note: Once the air filter is washed, dry it completely before returning it to its original position.

After cleaning be sure to return it to its original position.

Cautions

- Do not wash the air filter in water that is over 40°C or it may shrink.
- Do not expose the air filter to fire.
- Do not expose the air filter to direct sunlight for a long time when the air is very dirty.
- Clean the air filter more frequently.
- Do not inject water into motor

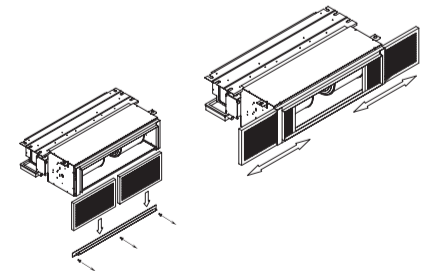

Literature Order Number: MS-SVN004-EN

Date: February 2011

Supersedes: November 2014

Stocking Location: Bangkok, Thailand

Trane has a policy of continuous product and product data improvement and reserves the right to change design and specifications without notice.